

THAI AUTOMATION CONTROL COMPANY LIMITED.

1259/28 Phrayasurain Rd, Bangchan Klongsamwa Bangkok 10510.

Tel : 02-044-1285 Fax : 02-9142114

Hotline : 089-1238699, 081-8156885, 086-3631353

E-mail : support@tacvisionsystem.com

Website : www.tacvisionsystem.com

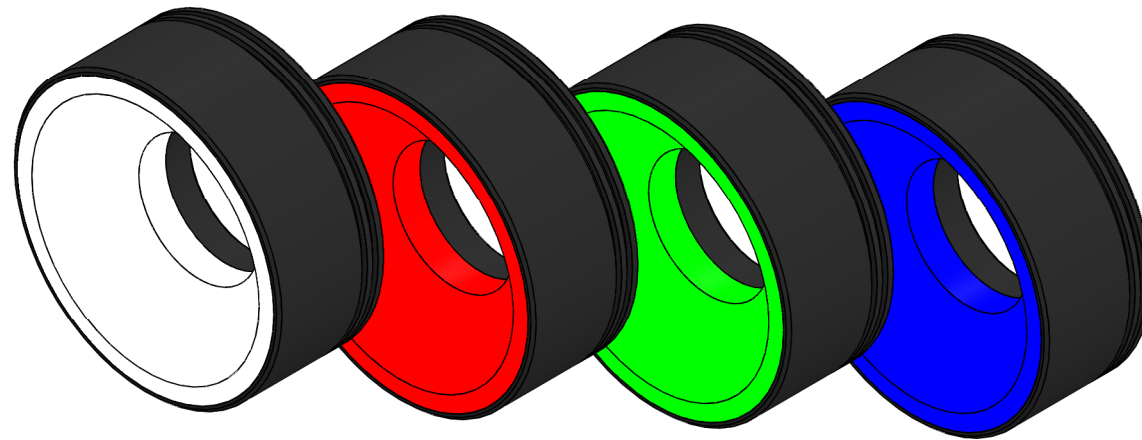
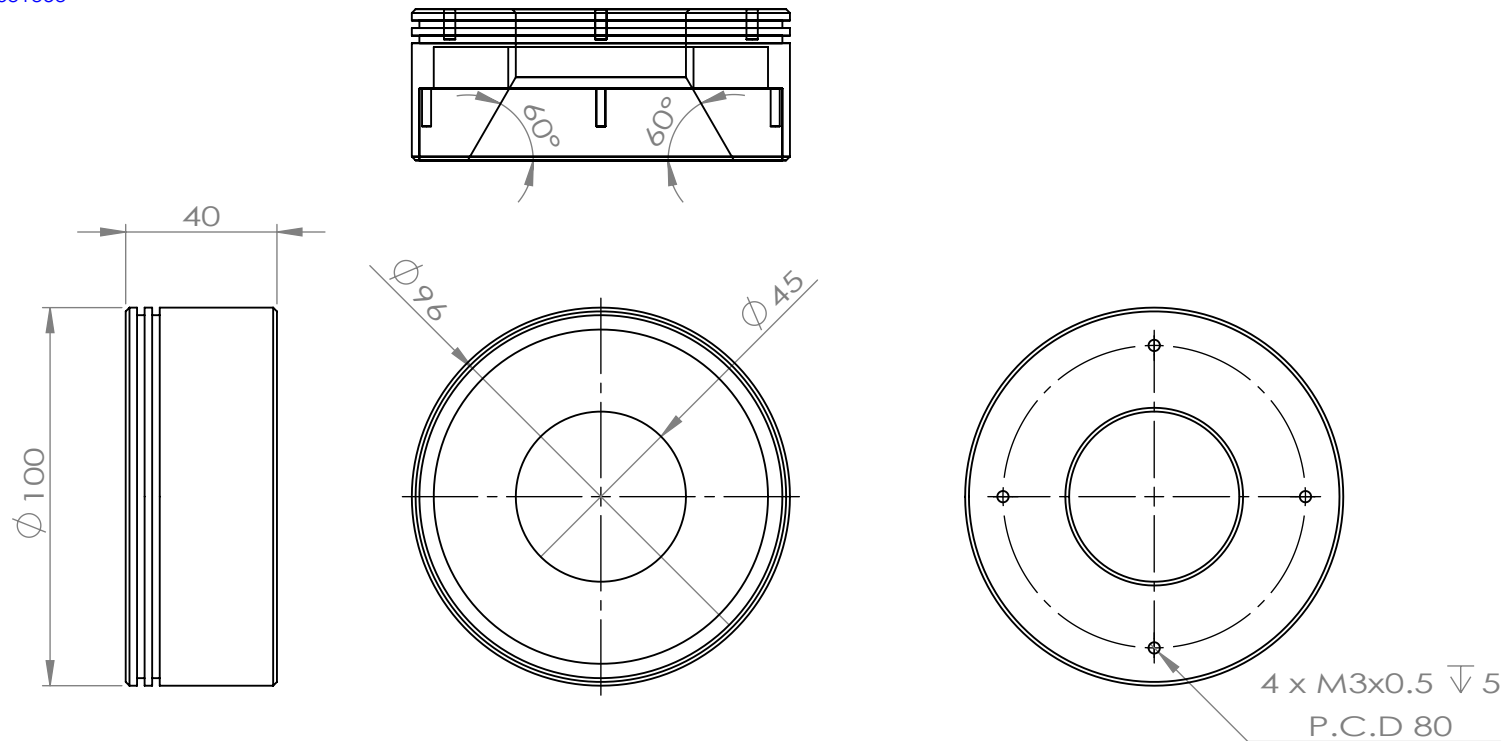

Model	Color	Voltage	Current
DLR-10040-60-24-R	Red	24V	128.5mA
DLR-10040-60-24-G	Green	24V	135mA
DLR-10040-60-24-B	Blue	24V	135mA
DLR-10040-60-24-W	White	24V	135mA

TAC

MATERIAL: Aluminium
(Black Anodize)

DWG NO. DLR-10040-60-24-X

A4

WEIGHT:

SCALE:1:2

SHEET 1 OF 1